

COMBINATION PLIER

SKU : 2100

FINEST IN THE
WORLD OF HANDTOOLS | **OAYKAY**™

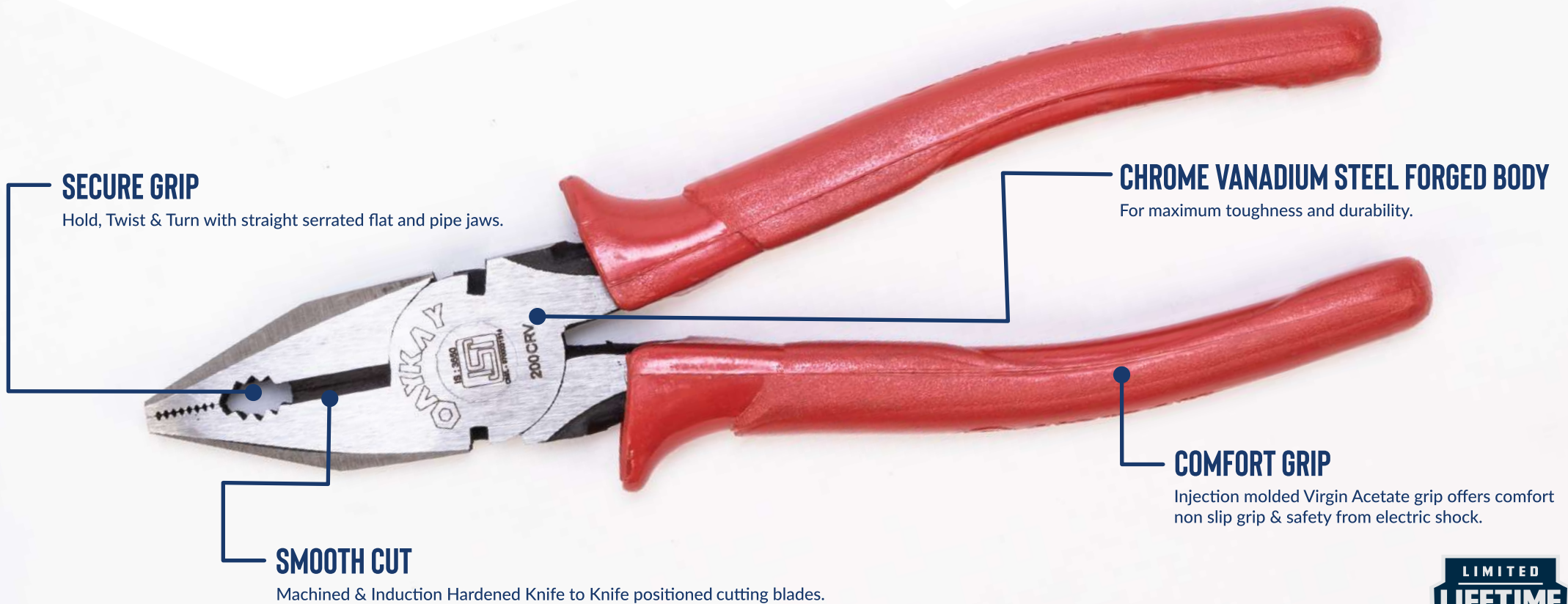

SECURE GRIP

Hold, Twist & Turn with straight serrated flat and pipe jaws.

CHROME VANADIUM STEEL FORGED BODY

For maximum toughness and durability.



COMFORT GRIP

Injection molded Virgin Acetate grip offers comfort non slip grip & safety from electric shock.

SMOOTH CUT

Machined & Induction Hardened Knife to Knife positioned cutting blades.

WE ARE EVERYWHERE.
WE ARE OAYKAY TOOLS.

Follow Us Online :    

Customer Helpline Number : 0181 2611301 / 02 / 03



www.oaykay.com

COMBINATION PLIER

SKU : 2100

FINEST IN THE
WORLD OF HANDTOOLS | **OAYKAY**™

INTRO -

HSN CODE : 82041110

Oaykay tools is a widely recognized brand of hardware, products designed for true professionals who takes their tools seriously. Oaykay Combination Side Cutting Pliers provide grip & more power for easier working. These pliers are designed for extreme durability and up to 2X longer life. Oaykay Combination pliers are forged & multi staged oil hardened in India's finest manufacturing unit it provides unmatched quality. Features gripping zones for flat or round material and induction-hardened cutting edges that cut soft & hard wire. These Pliers are widely used By Artisans, mechanics, electricians and electronic repairers. These are used for gripping, cutting, compressing, bending, twisting, extracting etc. Oaykay goes all out to bring award winning innovation and quality to each product, the appearance, fit and finish of every Oaykay product will make you proud you own the very best. Oaykay products are built with a solid foundation that makes for ultimate strength and durability.

Specification

Type	Combination Plier	Packaging	Color Pouches
Material	Chrome Vanadium steel	Testing	Torsion test, Tube gripping test, Handle load test, Insulation test.
Finishing	Phosphate finish / Polished		

Feature -

Plier is forged from chrome vanadium steel for extended life and strength. Chrome-vanadium is the steel you turn to when you need an extremely strong and durable tool.

Flat serrated gripping zones hold flat and round material for more contact area & nonslip bite with less damage to work piece.

Induction Hardening & CNC machining Knife-to-Knife angle blade allows them to be strong yet sharp, producing a satisfyingly smooth, clean cut that require minimal effort to cut soft, hard, piano, and ACSR wire.

Tested in accordance with ISI standards & insulated to withstand a pressure of 2500 volts (rms) ac or 4000 volts dc.

Full body underwent rigorous heat-treated process, and as a result we have a more durable product strong from any angle better than our competitors.

Non-slip virgin acetate coated insulated handle grips with trapezoidal feature for safe and non slip grip .

Confirms to IS:3650 Standards

WE ARE EVERYWHERE.
WE ARE OAYKAY TOOLS.

Follow Us Online : [f](#) [@](#) [t](#) [▶](#)

Customer Helpline Number : 0181 2611301 / 02 / 03



www.oaykay.com

COMBINATION PLIER

SKU : 2100

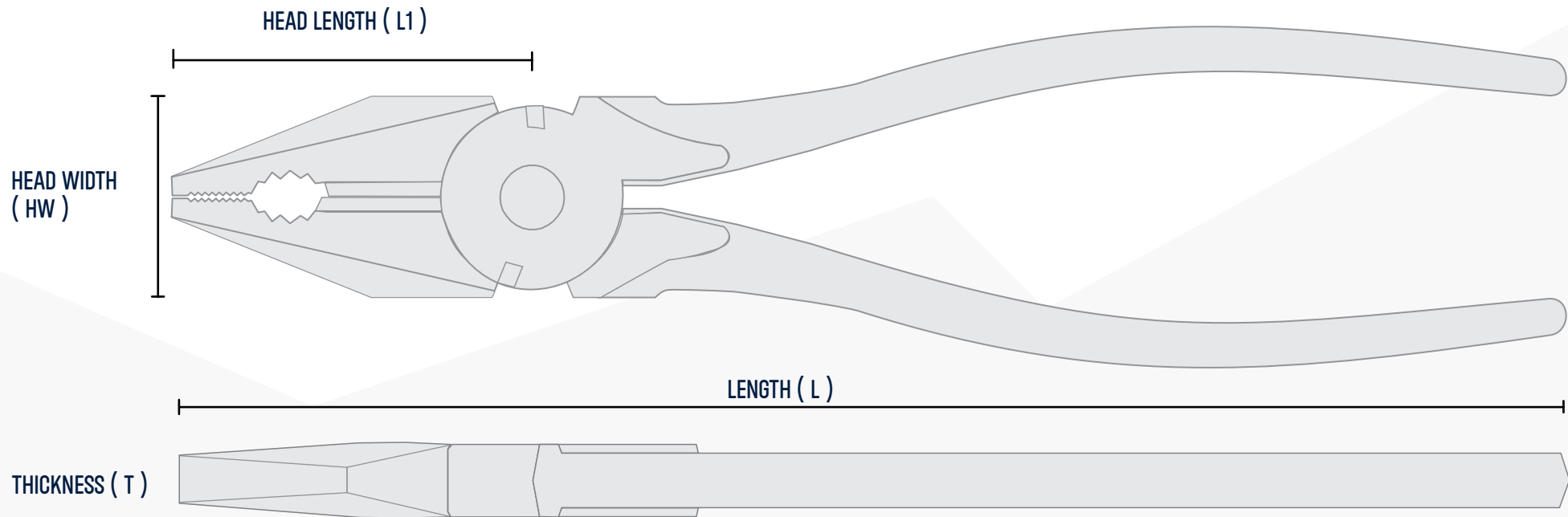

INDIVIDUAL SPANNER DATA SHEET

ART NO.	SIZE INCH	(L) MM ± 2.0	(T) MM ± 0.2	(L1) MM 0.3	(HW) MM ± 0.3
2100.33	6	150	-	-	-
2100.53	7	175	-	-	-
2100.73	8	200	11.0	53.0	30.0

WEIGHT GMS 	QTY. INNER CART.	QTY. MASTER CART.
-	10	100
-	10	80
275 APPROX	10	60

COMBINATION PLIER

SKU : 2100

FINEST IN THE
WORLD OF HANDTOOLS | **OAYKAY**™

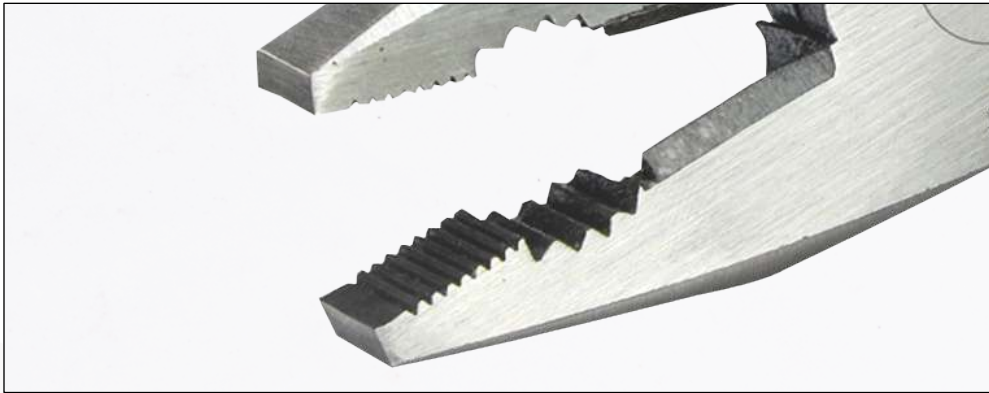

Straight Serrated jaws for strong grip on flat and round objects.

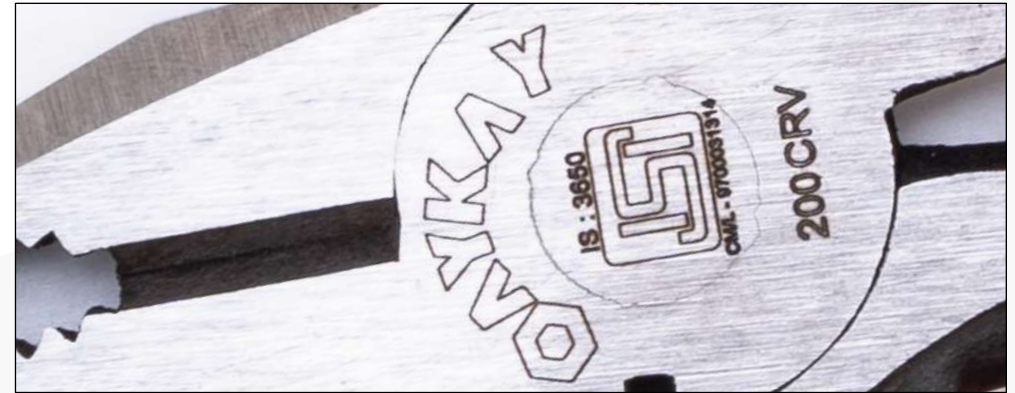

Oaykay Classic pivot action for smooth operation.

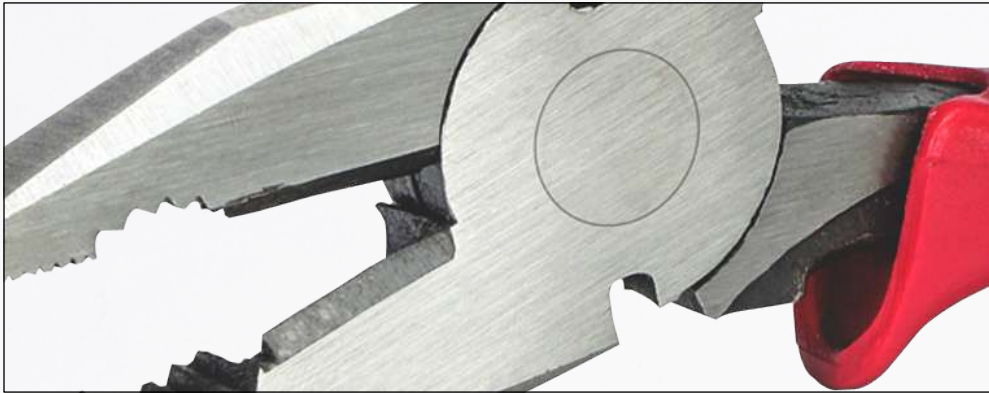

Induction Hardened Knife to Knife precisely angled cutting blade.



Non-slip trapezoidal grip for shock proof fine grip.

Warranty -

The Brand OAYKAY is a prime example of reliability and durability on account of its high quality and well-thought-out workmanship. Ideal for rough conditions in the workshop. And "Made in India". Limited lifetime warranty on this product, If you ever have an issue, contact our approved dealer or our corporate office on 9592-100-200.

Country of Origin : India

WE ARE EVERYWHERE.
WE ARE OAYKAY TOOLS.

Follow Us Online : [f](#) [@](#) [t](#) [v](#)

Customer Helpline Number : 0181 2611301 / 02 / 03

www.oaykay.com